

MCS100

Air Mass Flow Sensor

Overview

The MCS100 is a compact, fast response air mass flow sensor equipped with Azbil Corporation's original μ F (Micro Flow) sensor chip.

The MCS100 outputs mass flow signal according to the standard condition (20 °C, 1 atm) of the gas flow without temperature nor pressure compensation.

The MCS100 offers a various flow range, in addition to its wide rangeability.

The MCS100 is suited for a variety of flow measurements in such as physics and industry applications.

Features

- Compact and lightweight
33.5×10.5×17.0 mm, just 9 g (without cable)
- Fast response time
5 ms max.
- High accuracy and high repeatability
Accuracy: ± 5 %FS, Repeatability: ± 2.0 %FS (depending on each model number)

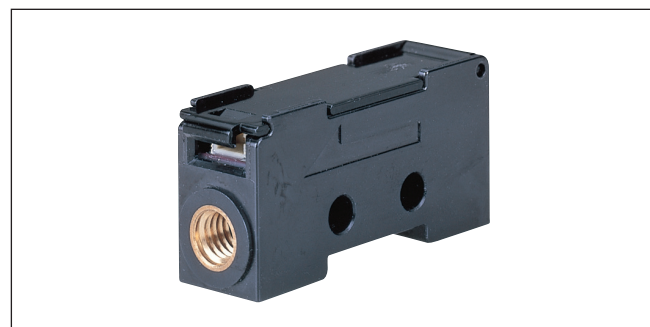

- Positive/Negative flow measurement due to its symmetrical structure.
- Low power consumption
12 mA max. at 24 V DC
- Free mounting position and not required straight piping length

Typical applications

- Air volume samplers
- Gas analyzers
- Gas detectors
- Pick and place detection for minute electronic/optical devices

Specifications

Model No.	MCS100A100	MCS100A104	MCS100A108
Flow range	-3 to +3 L/min	0 to 3 L/min	-0.5 to +0.5 L/min
	Volume flow converted to the conditions of 20 °C and 1 atm		
Applicable gas	Air and Nitrogen. Gas must be dry not containing any corrosive components (chlorine, sulfur, acid). The gas must also be free of any dust or oil mist.		
Response	5 ms max. (95 % response to a step state flow rate changing)		
Output signal	1 to 5 V DC (non-linear characteristics, refer to the standard output characteristics graph), allowable load resistance 10 k Ω or more		
Operating temperature range	0 to 50 °C (for both ambient temperature and gas temperature)		
Storage temperature	-10 to +60 °C		
Operating humidity range	10 to 80 %RH (no condensation allowed)		
Operating pressure range	-100 to +200 kPa (Range for assured pressure characteristics: -70 to +200 kPa)		
Pressure resistance	300 kPa		
Measurement accuracy	± 5 %FS max.	± 5 %FS max.	± 5 %FS max.
	Output voltage 4 V (5 to 1 V) for full scale		
Typical characteristics of output voltage	0.0 L/min: 3.00 \pm 0.15 V 0.5 L/min: 3.88 \pm 0.15 V 1.5 L/min: 4.49 \pm 0.15 V 3.0 L/min: 5.00 \pm 0.20 V	0.0 L/min: 1.00 \pm 0.20 V 0.5 L/min: 2.75 \pm 0.15 V 1.5 L/min: 3.96 \pm 0.24 V 3.0 L/min: 5.00 \pm 0.20 V	0.0 L/min: 3.00 \pm 0.20 V 0.1 L/min: 3.80 \pm 0.20 V 0.3 L/min: 4.55 \pm 0.20 V 0.5 L/min: 5.00 \pm 0.20 V
	Full scale is to the output voltage 4 V under the conditions of 20 °C and 1 atm. (101.325 kPa abs.)		

Model No.	MCS100A100	MCS100A104	MCS100A108
Repeatability	±3.5 %FS max.	±7.0 %FS max.	±2.0 %FS max.
	Under the same temperature and pressure conditions. Output voltage 4 V (5 to 1 V) for full scale.		
Pressure characteristics	±0.01 %FS/kPa	±0.02 %FS/kPa	±0.01 %FS/kPa
	Pressure range: -70 to +200 kPa Full scale is to the output voltage 4 V under the conditions of 20 °C and 1 atm. (101.325 kPa abs.).		
Temperature characteristics	0.0 L/min: ±0.1 %FS/°C 1.5 L/min: ±0.15 %FS/°C	0.0 L/min: ±0.1 %FS/°C 1.5 L/min: ±0.15 %FS/°C	0.0 L/min: ±0.1 %FS/°C 0.3 L/min: ±0.15 %FS/°C
	Temperature range: 0 to 50 °C Full scale is to the output voltage 4 V under the conditions of 20 °C and 1 atm. (101.325 kPa abs.).		
Power supply voltage	12 to 24 V DC, Ripple: 5 % max. at 12 V DC drive and 10 % max. at 24 V DC drive.*2		
Power fluctuation range	When 12 V DC drive: ±2 %FS max. to the output value at 12 V DC within the range of 11.4 to 13.2 V DC. When 24 V DC drive: ±2 %FS max. to the output value at 24 V DC within the range of 21.6 to 26.4 V DC.		
Current consumption	12 mA max. at 24 V DC		
Dielectric strength	500 V AC (1 min) or 600 V AC (1 sec) between each external connector terminal and body		
Insulation resistance	50 MΩ (500 V DC megger) between each external connector terminal and body		
Connection type	M5 female (brass insertion), tightening torque 2.5 N·m max.		
Material	Parts exposed to gas: PPS resin, ceramic (printed wiring board) and brass (connecting part) Cover: PC (Polycarbonate) resin		
Mounting position	Free		
Mounting conditions	When using the mounting holes of body, use M3 screws and tighten with 0.6 N·m max. torque. Install a filter in upstream side of this device to trap the dust or oil mist of 10 μm or larger.		
Straight piping length	Not required for both upstream and downstream sides		
Vibration resistance	10 to 55 Hz, 1.5 mm peak-to-peak amplitude, 2 hours each in XYZ directions		
Weight (mass)	9 g		
Electronic connection (Dedicated connector connection)	Cable with dedicated connector (sold separately): 81446888-001 (2 m), 81446888-002 (3 m) MCS side: SM03B-SRSS-G-TB manufactured by J.S.T.Mfg Co. Ltd., Counterpart side: SHR-03V-S-B (housing) and SSH-003GA-P2 (contact) manufactured by the same company.		

Model No.	MCS100A112	MCS100A116	MCS100A120
Flow range	0 to 0.5 L/min	0 to 5 L/min	0 to 10 L/min
	Volume flow converted to the conditions of 20 °C and 1 atm		
Applicable gas	Air and Nitrogen. Gas must be dry not containing any corrosive components (chlorine, sulfur, acid). The gas must also be free of any dust or oil mist.		
Response	5 ms max. (95 % response to a step state flow rate changing)		
Output signal	1 to 5 V DC (non-linear characteristics, refer to the standard output characteristics graph), allowable load resistance 10 kΩ or more		
Operating temperature range	0 to 50 °C (for both ambient temperature and gas temperature)		
Storage temperature	-10 to +60 °C		
Operating humidity range	10 to 80 %RH (no condensation allowed)		
Operating pressure range	-100 to +200 kPa (Range for assured pressure characteristics: -70 to +200 kPa)		
Pressure resistance	300 kPa		
Measurement accuracy	±6 %FS max.	±5 %FS max.	±5 %FS max.
	Output voltage 4 V (5 to 1 V) for full scale		
Typical characteristics of output voltage	0.0 L/min: 1.00±0.24 V 0.1 L/min: 2.58±0.24 V 0.3 L/min: 4.13±0.24 V 0.5 L/min: 5.00±0.24 V	0.0 L/min: 1.00±0.20 V 1.0 L/min: 2.95±0.20 V 3.0 L/min: 4.29±0.20 V 5.0 L/min: 5.00±0.20 V	0.0 L/min: 1.00±0.20 V 3.0 L/min: 3.89±0.20 V 5.0 L/min: 4.46±0.20 V 10.0 L/min: 5.00±0.20 V
	Full scale is to the output voltage 4 V under the conditions of 20 °C and 1 atm. (101.325 kPa abs.).		
Repeatability	±2.0 %FS max.	±7 %FS max.	±7 %FS max.
	Under the same temperature and pressure conditions. Output voltage 4 V (5 to 1 V) for full scale.		
Pressure characteristics	±0.02 %FS/kPa	-70 to 0 kPa: ±0.02 %FS/kPa 0 to 200 kPa: ±0.01 %FS/kPa	-70 to 0 kPa: ±0.03 %FS/kPa 0 to 200 kPa: ±0.01 %FS/kPa
	Pressure range: -70 to +200 kPa Full scale is to the output voltage 4 V under the conditions of 20 °C and 1 atm. (101.325 kPa abs.).		
Temperature characteristics	0.0 L/min: ±0.2 %FS/°C 0.3 L/min: ±0.2 %FS/°C	0.0 L/min: ±0.1 %FS/°C 3.0 L/min: ±0.15 %FS/°C	0.0 L/min: ±0.1 %FS/°C 5.0 L/min: ±0.2 %FS/°C
	Temperature range: 0 to 50 °C Full scale is to the output voltage 4 V under the conditions of 20 °C and 1 atm. (101.325 kPa abs.).		
Power supply voltage	12 to 24 V DC, Ripple: 5 % max. at 12 V DC drive and 10 % max. at 24 V DC drive.*2		
Power fluctuation range	When 12 V DC drive: ±2 %FS max. to the output value at 12 V DC within the range of 11.4 to 13.2 V DC. When 24 V DC drive: ±2 %FS max. to the output value at 24 V DC within the range of 21.6 to 26.4 V DC.		

Model No.	MCS100A112	MCS100A116	MCS100A120
Current consumption	12 mA max. at 24 V DC		
Dielectric strength	500 V AC (1 min) or 600 V AC (1 sec) between each external connector terminal and body		
Insulation resistance	50 MΩ (500 V DC megger) between each external connector terminal and body		
Connection type	M5 female (brass insertion), tightening torque 2.5 N·m max.		
Material	Parts exposed to gas: PPS resin, ceramic (printed wiring board) and brass (connecting part) Cover: PC (Polycarbonate) resin		
Mounting position	Free		
Mounting conditions	When using the mounting holes of body, use M3 screws and tighten with 0.6 N·m max. torque. Install a filter in upstream side of this device to trap the dust or oil mist of 10 μm or larger.		
Straight piping length	Not required for both upstream and downstream sides		
Vibration resistance	10 to 55 Hz, 1.5 mm peak-to-peak amplitude, 2 hours each in XYZ directions		
Weight (mass)	9 g		
Electronic connection (Dedicated connector connection)	Cable with dedicated connector (sold separately): 81446888-001 (2 m), 81446888-002 (3 m) MCS side: SM03B-SRSS-G-TB manufactured by J.S.T.Mfg Co. Ltd., Counterpart side: SHR-03V-S-B (housing) and SSH-003GA-P.2 (contact) manufactured by the same company.		

*1. For the %FS in the above description, 4 V of output voltage (1 to 5 V) is specified as a full-scale.

*2. When used at 24 V DC drive, the output change may occur within ±1 %FS max. after flowrate stabilization in the vicinity of measurement range upper limit flowrate (the amount of drift after 500 s from the flowrate stabilization).

Standard flow rate characteristics

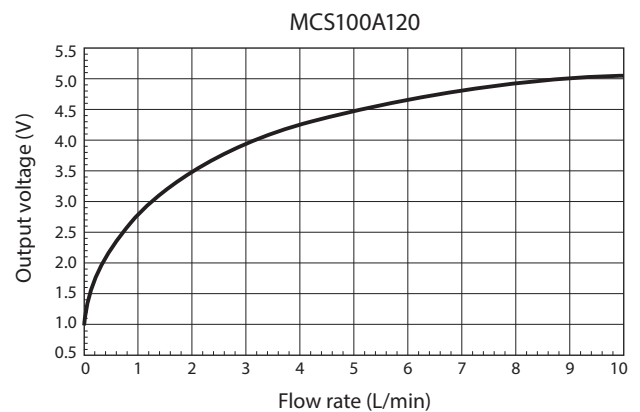
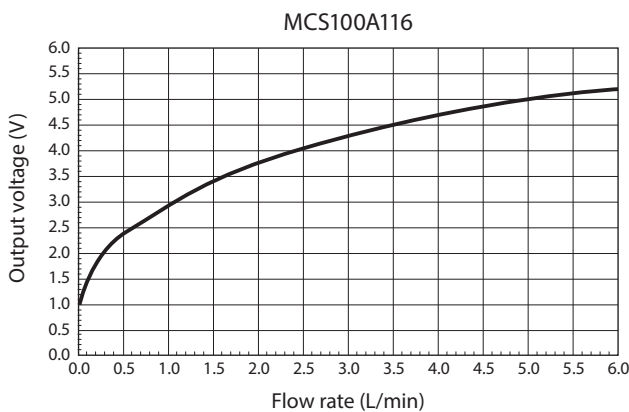
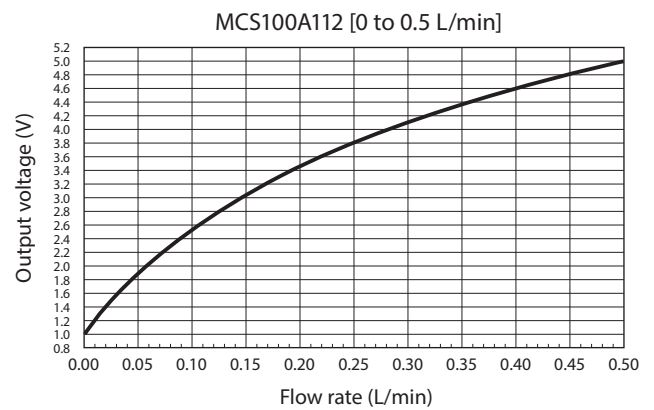
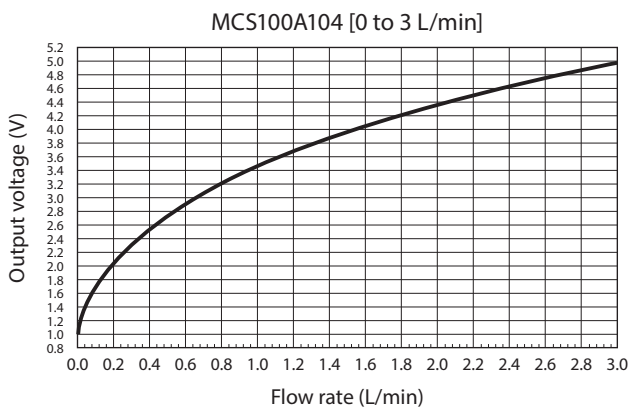
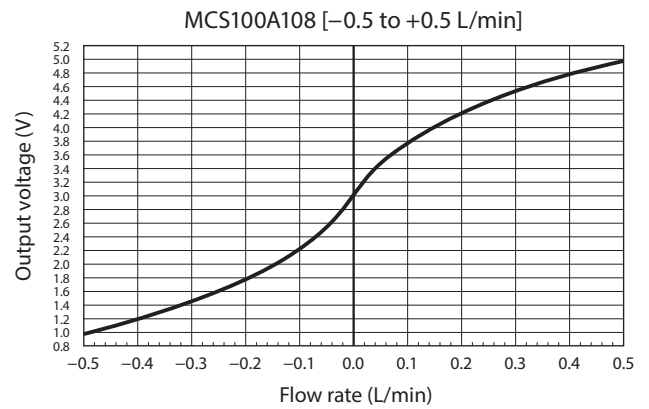
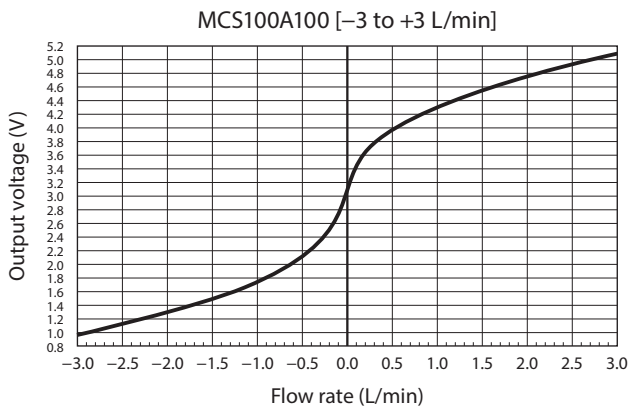

5 ms fast response by μ F (Micro Flow) sensor of Azbil Corporation's original technology

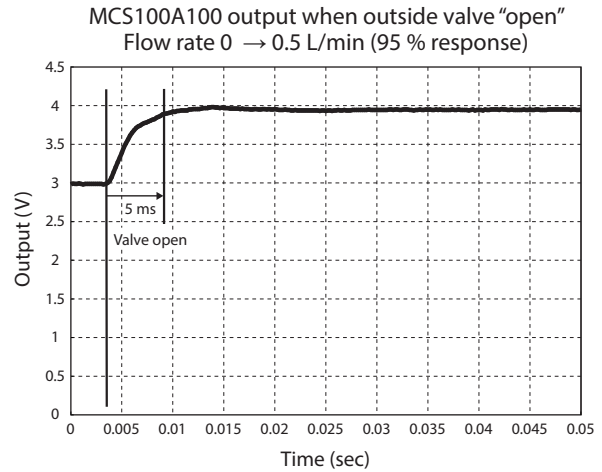
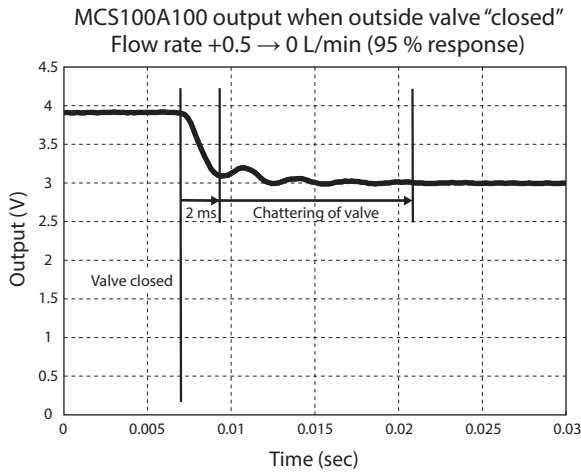

Connection

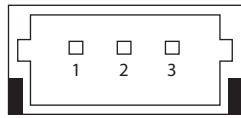

View from connector terminal side

Applicable connector:
Housing: SHR-03V-S-B made by J.S.T. Mfg Co. Ltd.
Contact pin: SSH-003GA-P0.2 made by J.S.T. Mfg Co. Ltd.

Pin No.	Signal name	Description
1	V+	Power supply +
2	GND	GND
3	Vout	Sensor output

Note: Not insulated between inputs and outputs

Recommended connection example

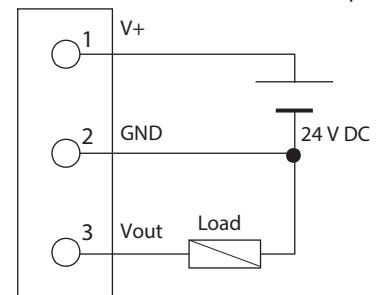

Note: Allowable load resistance is 10 k Ω min.

Dimensions

Unit: mm

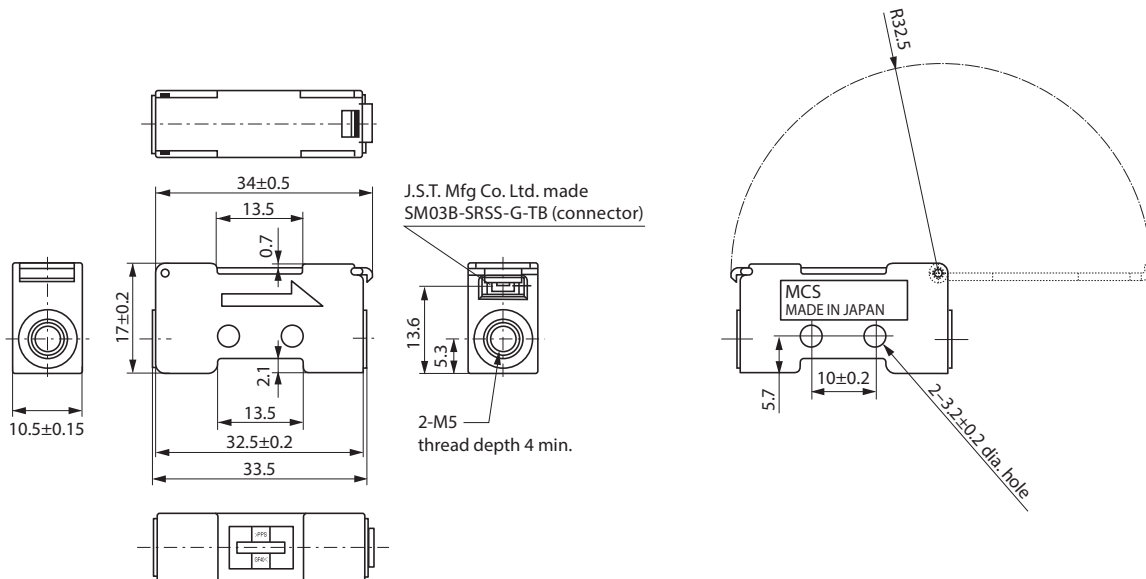

Please read "Terms and Conditions" from the following URL before ordering and use.
<http://www.azbil.com/products/factory/order.html>

Specifications are subject to change without notice.

azbil

Azbil Corporation
Advanced Automation Company

1-12-2 Kawana, Fujisawa
Kanagawa 251-8522 Japan
URL: <http://www.azbil.com/>

1st Edition: Apr. 2005
4th Edition: Nov. 2017

No part of this publication may be reproduced or duplicated without the prior written permission of Azbil Corporation.